

# EMISSION CONTROL SYSTEMS (2JZ-GTE)

## SYSTEM PURPOSE

The emission control systems are installed to reduce the amount of CO, HC and NOx exhausted from the engine ((3), (4) and (5)), to prevent the atmospheric release of blow-by gas-containing HC (1) and evaporated fuel containing HC being released from the fuel tank (2).

The function of each system is shown in the following table.

System	Abbreviation	Function
(1) Positive Crankcase Ventilation	PCV	Reduces HC
(2) Evaporative Emission Control	EVAP	Reduces evaporated HC
(3) Exhaust Gas Recirculation	EGR	Reduces NOx
(4) Three-way Catalytic Converter	TWC	Reduces CO, HC and NOx
(5) Sequential Multiport Fuel Injection*	SFI	Injects a precisely timed, optimum amount of fuel for reduced exhaust emissions

Remark: \* For inspection and repair of the SFI system, refer to the SFI section this manual.

## PREPARATION

### RECOMMENDED TOOLS

	09082-00050 TOYOTA Electrical Tester Set	
---	--	--

## EQUIPMENT

Tachometer	
Torque wrench	
Vacuum gauge	

# EMISSION CONTROL SYSTEMS (2JZ-GTE)

## SYSTEM PURPOSE

The emission control systems are installed to reduce the amount of CO, HC and NOx exhausted from the engine ((3), (4) and (5)), to prevent the atmospheric release of blow-by gas-containing HC (1) and evaporated fuel containing HC being released from the fuel tank (2).

The function of each system is shown in the following table.

System	Abbreviation	Function
(1) Positive Crankcase Ventilation	PCV	Reduces HC
(2) Evaporative Emission Control	EVAP	Reduces evaporated HC
(3) Exhaust Gas Recirculation	EGR	Reduces NOx
(4) Three-way Catalytic Converter	TWC	Reduces CO, HC and NOx
(5) Sequential Multiport Fuel Injection*	SFI	Injects a precisely timed, optimum amount of fuel for reduced exhaust emissions

Remark: \* For inspection and repair of the SFI system, refer to the SFI section this manual.

## PREPARATION

### RECOMMENDED TOOLS

	09082-00050 TOYOTA Electrical Tester Set	
---	--	--

## EQUIPMENT

Tachometer	
Torque wrench	
Vacuum gauge	

# LAYOUT AND SCHEMATIC DRAWING

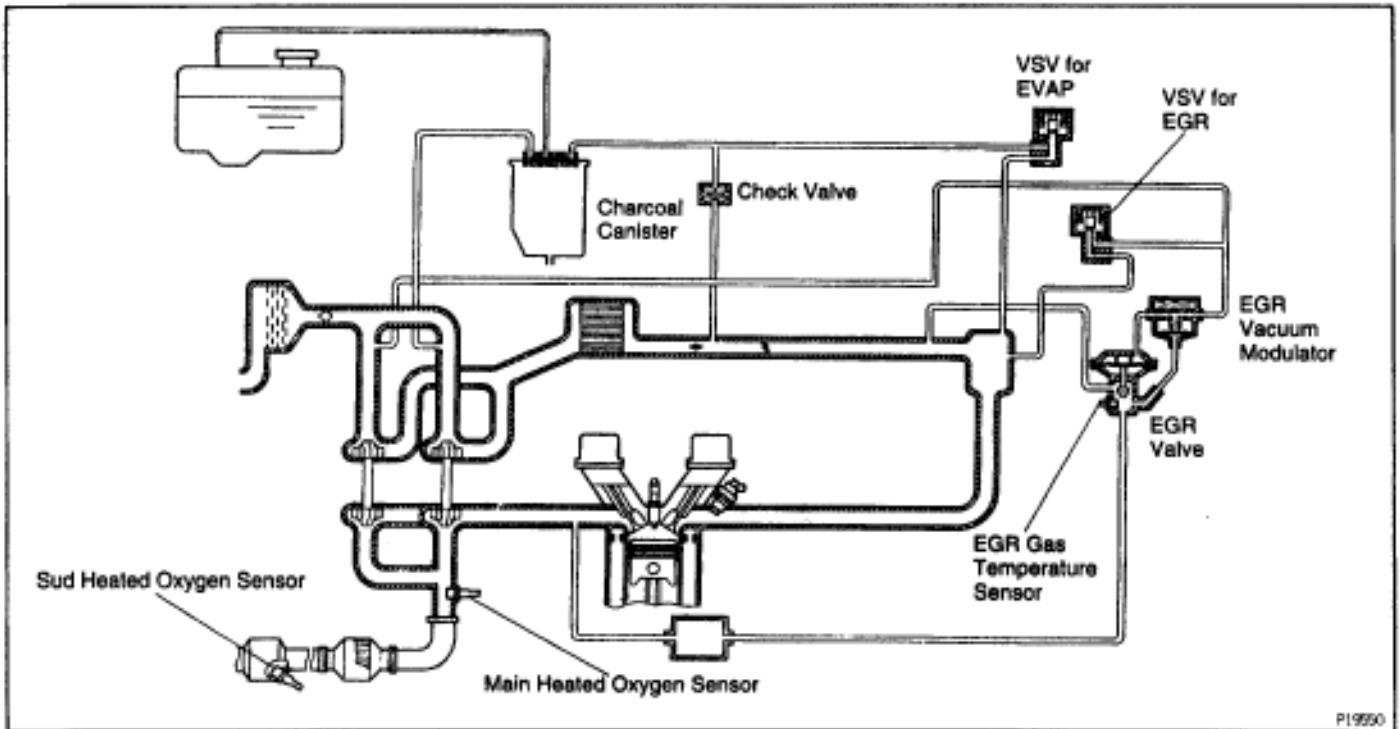
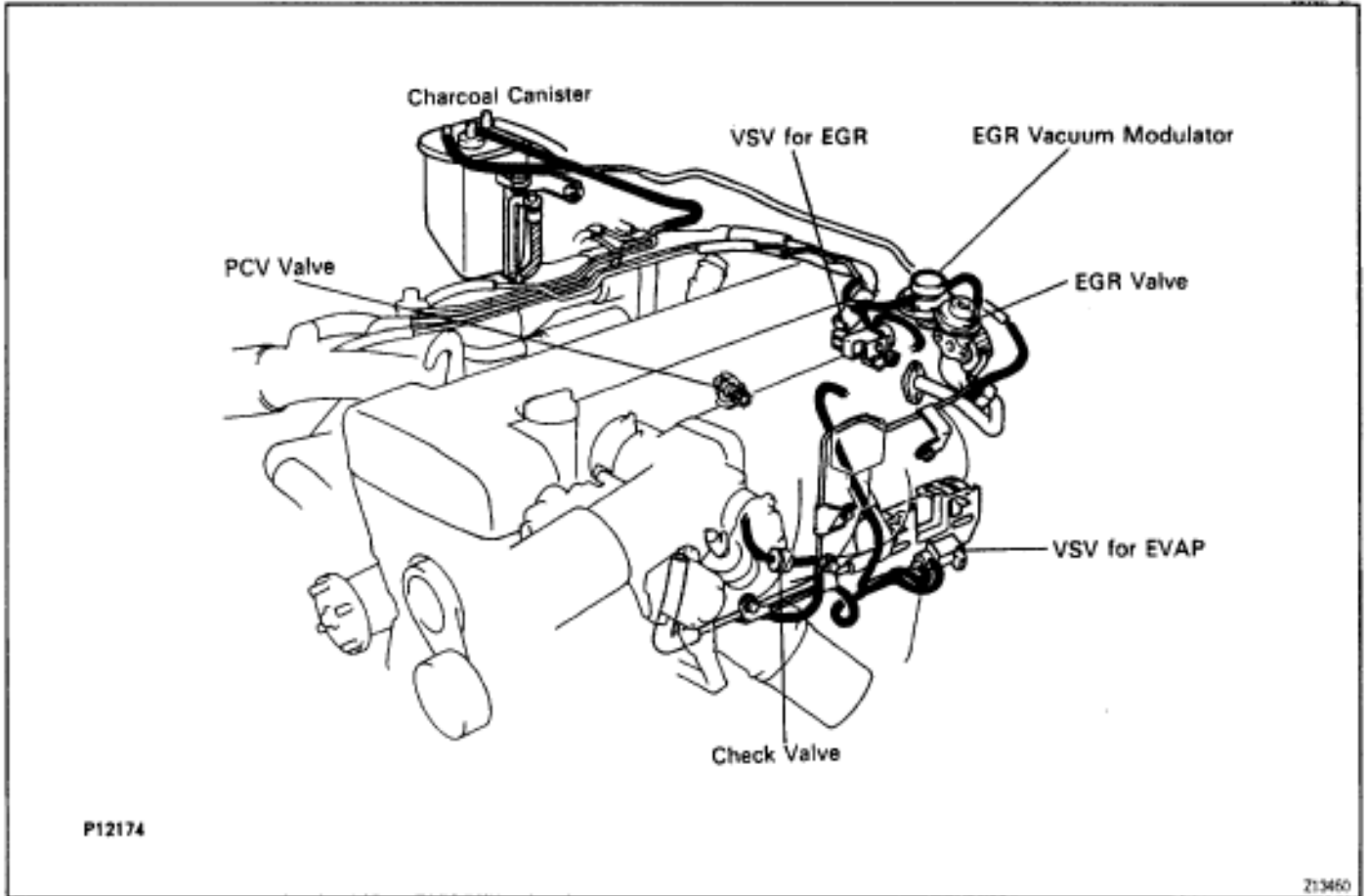

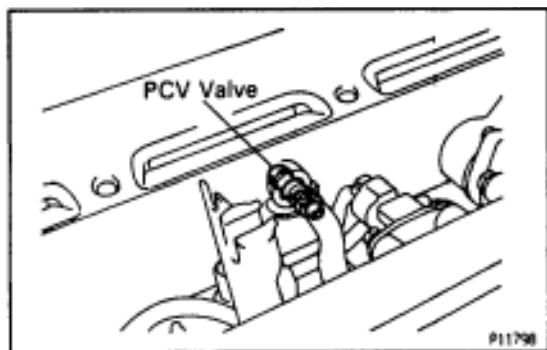

## POSITIVE CRANKCASE VENTILATION (PCV) SYSTEM

### PCV VALVE INSPECTION

#### 1. REMOVE PCV VALVE

- (a) Disconnect the PCV hose from the PCV valve.
- (b) Remove the PCV valve.

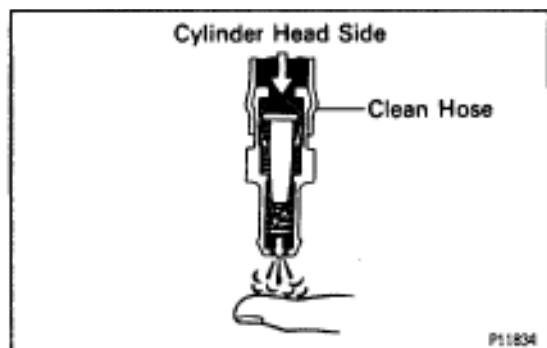

#### 2. INSTALL CLEAN HOSE TO PCV VALVE

#### 3. INSPECT PCV VALVE OPERATION

- (a) Blow air into the cylinder head side, and check that air passes through easily.

**CAUTION:** Do not suck air through the valve. Petroleum substances inside the valve are harmful.

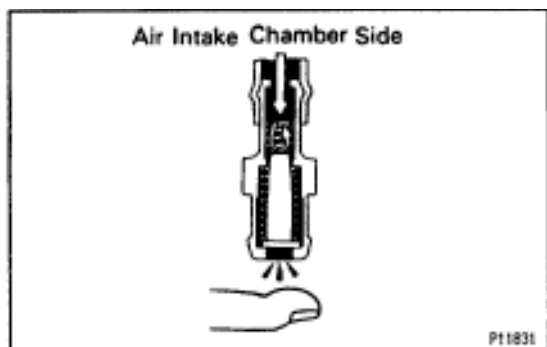

- (b) Blow air into the air intake chamber side, and check that air passes through with difficulty.

If operation is not as specified, replace the PCV valve.

#### 4. REMOVE CLEAN HOSE FROM PCV VALVE

#### 5. REINSTALL PCV VALVE

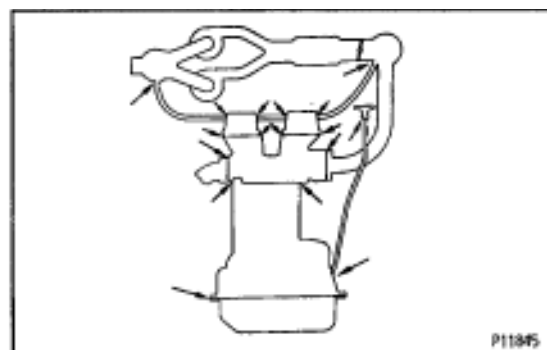

## PCV HOSES AND CONNECTORS INSPECTION

### VISUALLY INSPECT HOSES, CONNECTIONS AND GASKETS

Check for cracks, leaks or damage.

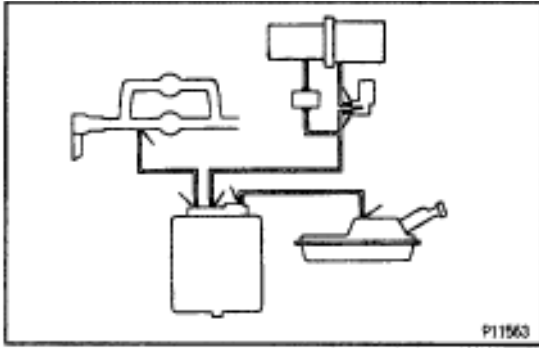

## EVAPORATIVE EMISSION (EVAP) CONTROL SYSTEM FUEL VAPOR LINES, FUEL TANK AND TANK CAP INSPECTION

1. **VISUALLY INSPECT LINES AND CONNECTIONS**  
Look for loose connections, sharp bends or damage.
2. **VISUALLY INSPECT FUEL TANK**  
Look for deformation, cracks or fuel leakage.
3. **VISUALLY INSPECT FUEL TANK CAP**  
Check if the cap and/or gasket are deformed or damaged. If necessary, repair or replace the cap.

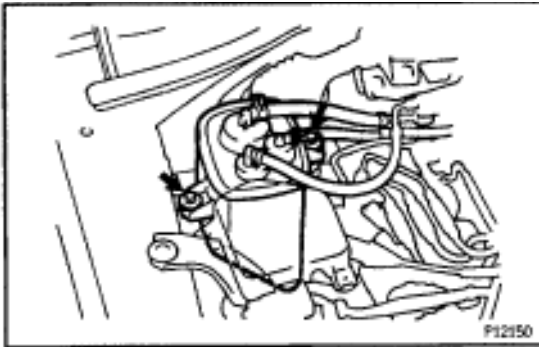
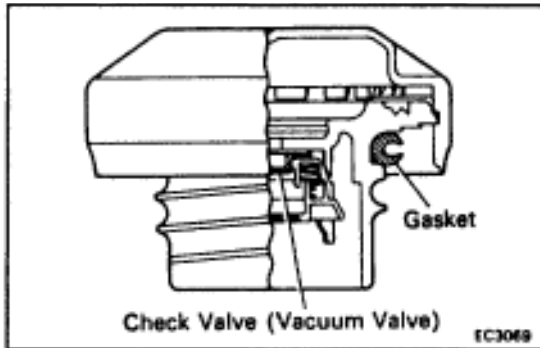

## CHARCOAL CANISTER INSPECTION

1. **REMOVE CHARCOAL CANISTER**

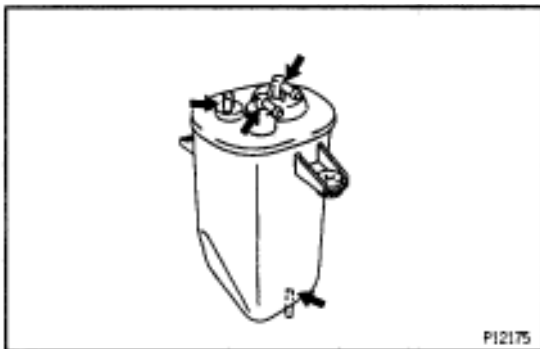

2. **VISUALLY INSPECT CHARCOAL CANISTER**  
Look for cracks or damage.

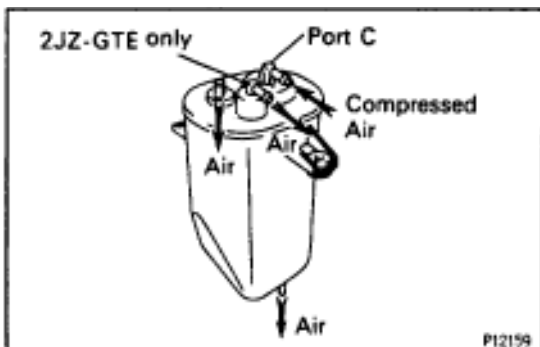

3. **CHECK FOR CLOGGED FILTER AND STUCK CHECK VALVE**

- (a) Using low pressure compressed air (4.71 kPa (0.048 kgf/cm<sup>2</sup>, 0.68 psi)), blow into port C and check that air flows without resistance from the other ports.

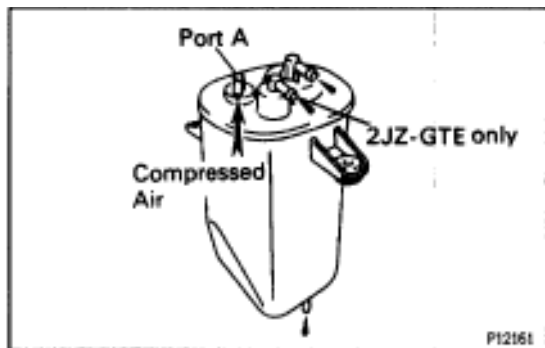

- (b) Blow air (4.71 kPa (0.048 kgf/cm<sup>2</sup>, 0.68 psi)) into port A, and check that air does not flow from the other ports.

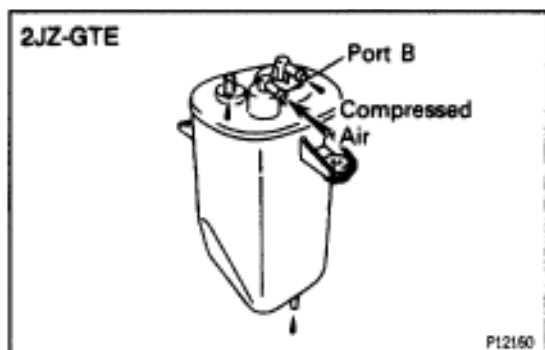

- (c) Blow air (4.71 kPa (0.048 kgf/cm<sup>2</sup>, 0.68 psi)) into port B, and check that air does not flow from the other ports.  
If operation is not as specified, replace the charcoal canister.

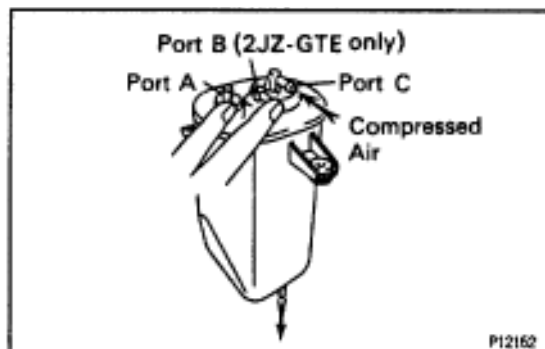

#### 4. CLEAN FILTER IN CANISTER

Clean the filter by blowing 294 kPa (3 kgf/cm<sup>2</sup>, 43 psi) of compressed air into port C while holding port A and B closed.

##### NOTICE:

- Do not attempt to wash the canister.
- No activated carbon should come out.

#### 5. REINSTALL CHARCOAL CANISTER

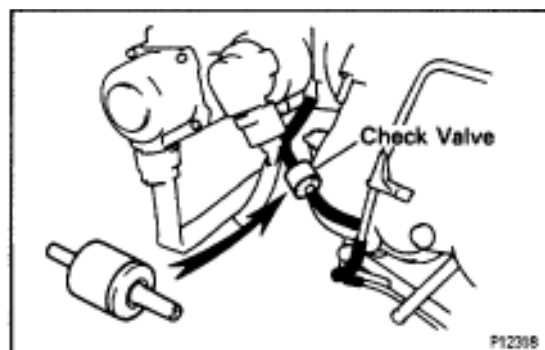

## VSV INSPECTION

(See VSV for EVAP in SFI System)

## CHECK VALVE INSPECTION

#### 1. REMOVE CHECK VALVE

#### 2. INSPECT CHECK VALVE

- (a) Check that air flows from the blue port to the black port.  
(b) Check that air does not flow from the black port to the blue port.

If operation is not as specified, replace the check valve.

#### 3. REINSTALL CHECK VALVE

HINT: Install the check valve with the black port facing the purge port side of the throttle body.

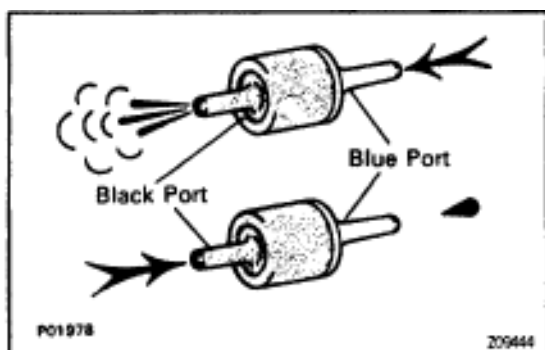

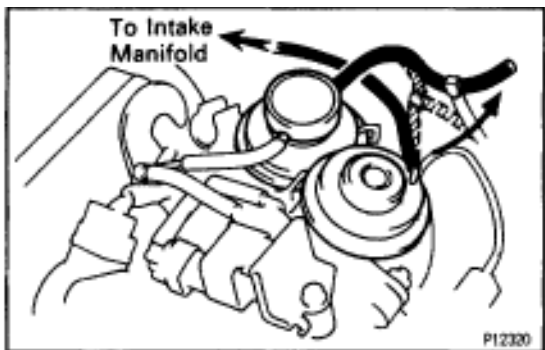
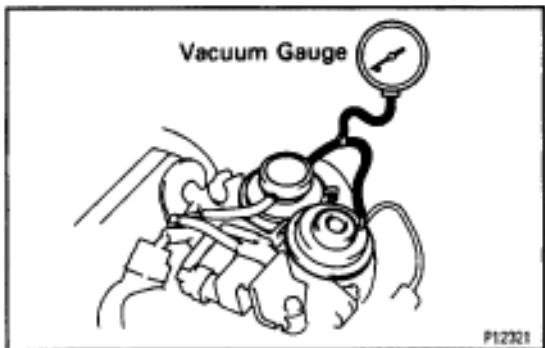
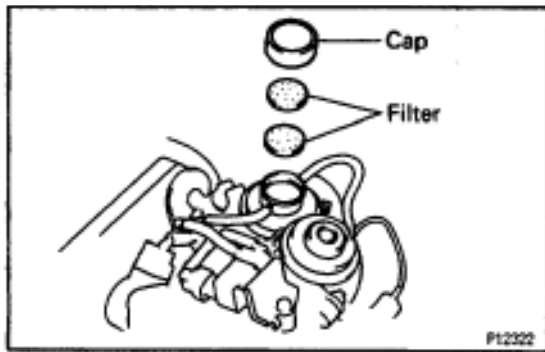

## EXHAUST GAS RECIRCULATION (EGR) SYSTEM

### EGR SYSTEM INSPECTION

#### 1. INSPECT AND CLEAN FILTER IN EGR VACUUM MODULATOR

- (a) Remove the cap and 2 filters.
- (b) Check the filter for contamination or damage.
- (c) Using compressed air, clean the filter.
- (d) Reinstall the 2 filters and cap.

HINT: Install the filter with the coarser surface facing the atmospheric side (outward).

#### 2. INSTALL VACUUM GAUGE

Using a 3-way connector, connect a vacuum gauge to the hose between the EGR valve and vacuum modulator.

#### 3. INSPECT SEATING OF EGR VALVE

Start the engine and check that the engine starts and runs at idle.

#### 4. INSPECT VSV OPERATION WITH COLD ENGINE

- (a) The coolant temperature should be below 50°C (122°F).
- (b) From idle, race the engine to 3,500–4,000 rpm (throttle valve opening angle to about 1/3 of maximum).
- (c) Check that the EGR pipe is not hot.
- (d) Check that the vacuum gauge indicates zero.

#### 5. INSPECT VSV OPERATION WITH HOT ENGINE

- (a) Warm up the engine to above 50°C (122°F)
- (b) From idle, race the engine to 3,500–4,000 rpm (throttle valve opening angle to about 1/3 of maximum).
- (c) Check that the vacuum gauge indicates low vacuum.

#### 6. REMOVE VACUUM GAUGE

Remove the vacuum gauge, and reconnect the vacuum hoses to their proper locations.

#### 7. INSPECT EGR VALVE

- (a) Apply vacuum directly to the EGR valve with the engine idling.
- (b) Check that the engine runs rough or dies.
- (c) Reconnect the vacuum hoses to the proper locations.

**IF NO PROBLEM IS FOUND DURING THIS INSPECTION, SYSTEM IS NORMAL; OTHERWISE INSPECT EACH PART**

## VSV INSPECTION

(See VSV for EGR in SFI System)

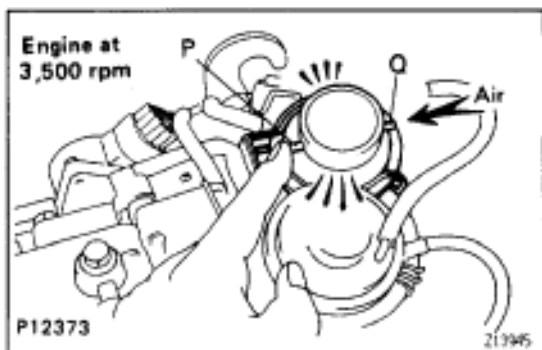
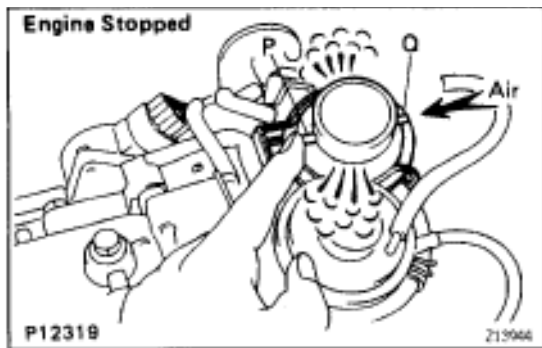

## EGR VACUUM MODULATOR INSPECTION

### 1. DISCONNECT VACUUM HOSES FROM EGR VACUUM MODULATOR

Disconnect the 2 vacuum hoses from ports P and Q of the EGR vacuum modulator.

### 2. INSPECT EGR VACUUM MODULATOR OPERATION

- (a) Block port P with your finger.
- (b) Blow air into port Q, and check that the air passes through to the air filter side freely.
- (c) Start the engine, and maintain speed at 3,500 rpm.
- (d) Repeat the above test. Check that there is a strong resistance to air flow.

### 3. RECONNECT VACUUM HOSES TO EGR VACUUM MODULATOR

Reconnect the 2 vacuum hoses to the proper locations.



## EGR VALVE INSPECTION

### 1. REMOVE EGR PIPE

- (a) Loosen the union nut of the EGR pipe.
- (b) Remove the 2 bolts, EGR pipe and gasket.

### 2. REMOVE EGR GAS TEMPERATURE SENSOR

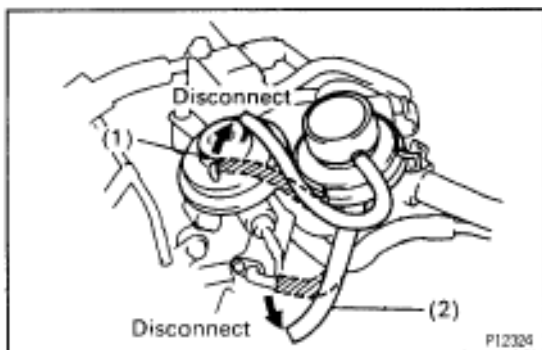

### 3. REMOVE EGR VALVE

- (a) Disconnect these hoses from the EGR valve:
  - (1) Vacuum hose
  - (2) Pressure hose

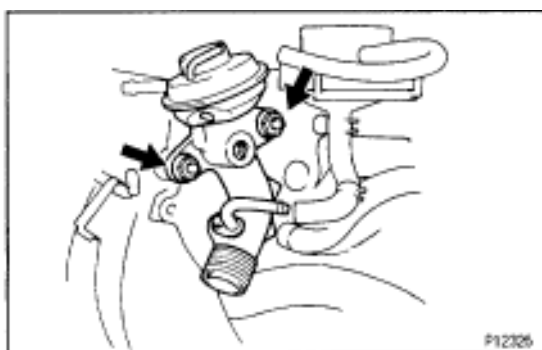

- (b) Remove the 2 nuts, EGR valve and gasket.

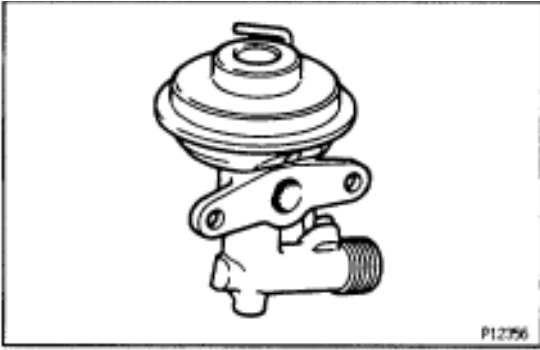

**4. INSPECT EGR VALVE**

Check for sticking and heavy carbon deposits.  
If a problem is found, replace the EGR valve.

**5. REINSTALL EGR VALVE**

(a) Place a new gasket on the air intake chamber.

(b) Install the EGR valve with the 2 nuts.

**Torque: 21 N·m (210 kgf·cm, 15 ft·lbf)**

(c) Reconnect the following hoses to the EGR valve:

- Vacuum hose
- Pressure hose

**6. REINSTALL EGR GAS TEMPERATURE SENSOR**

**Torque: 20 N·m (200 kgf·cm, 14 ft·lbf)**

**7. REINSTALL EGR PIPE**

(a) Temporarily install the union nut of the EGR pipe.

(b) Install a new gasket and the EGR pipe with the 2 bolts.

**Torque: 27 N·m (280 kgf·cm, 20 ft·lbf)**

(c) Tighten the union nut of the EGR pipe.

**Torque: 64 N·m (650 kgf·cm, 47 ft·lbf)**

## **THREE-WAY CATALYTIC CONVERTER (TWC) SYSTEM EXHAUST PIPE ASSEMBLY INSPECTION**

- 1. CHECK CONNECTIONS FOR LOOSENESS OR DAMAGE**
- 2. CHECK CLAMPS FOR WEAKNESS, CRACKS OR DAMAGE**

## **TWC INSPECTION**

### **CHECK FOR DENTS OR DAMAGE**

If any part of the protector is damaged or dented to the extent that it contacts the TWC, repair or replace it.

## **HEAT INSULATOR INSPECTION**

- 1. CHECK HEAT INSULATOR FOR DAMAGE**
- 2. CHECK FOR ADEQUATE CLEARANCE BETWEEN CATALYTIC CONVERTER AND HEAT INSULATOR**

## COMPONENTS FOR FRONT TWC REPLACEMENT

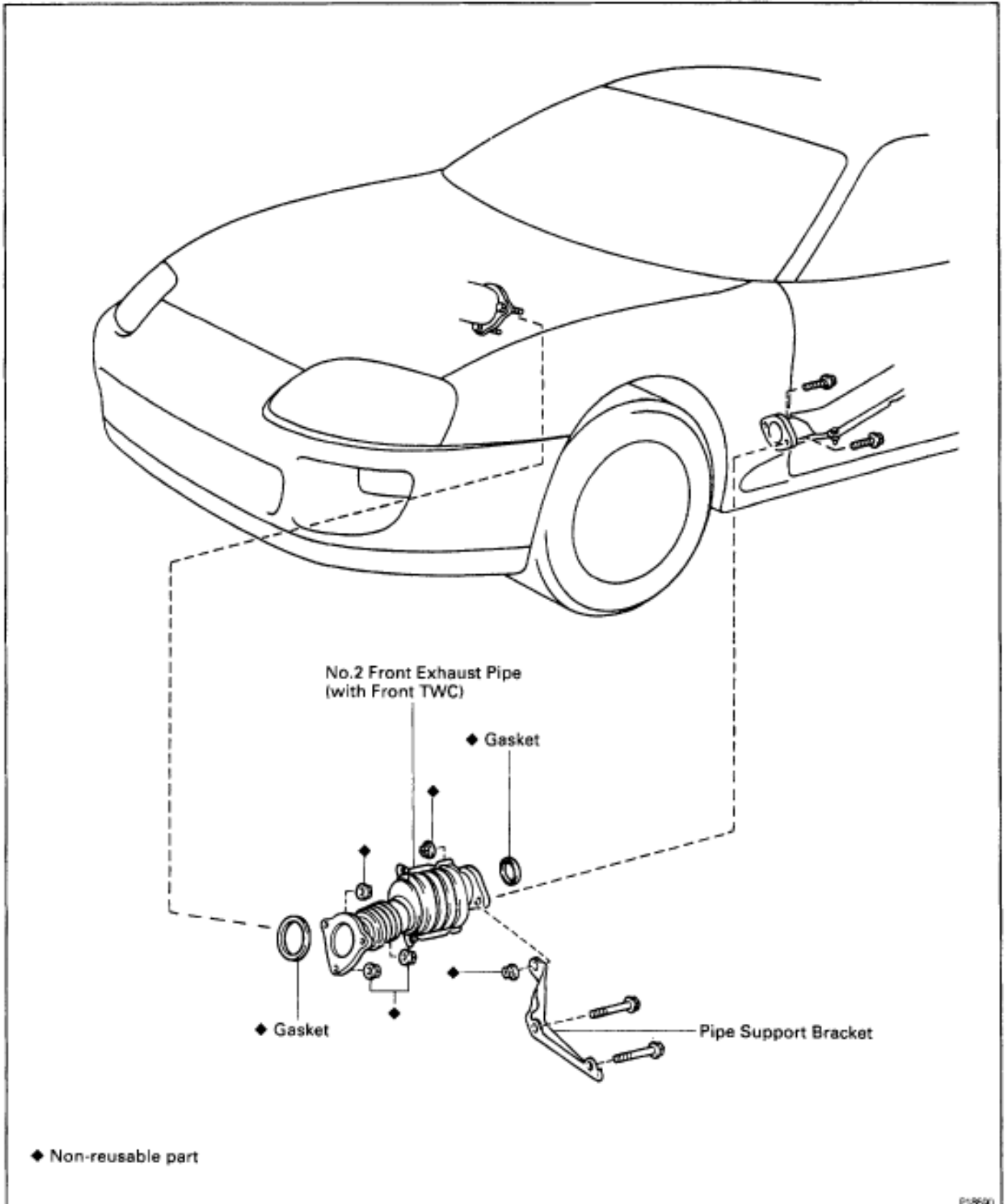

# COMPONENTS FOR REAR TWC REPLACEMENT

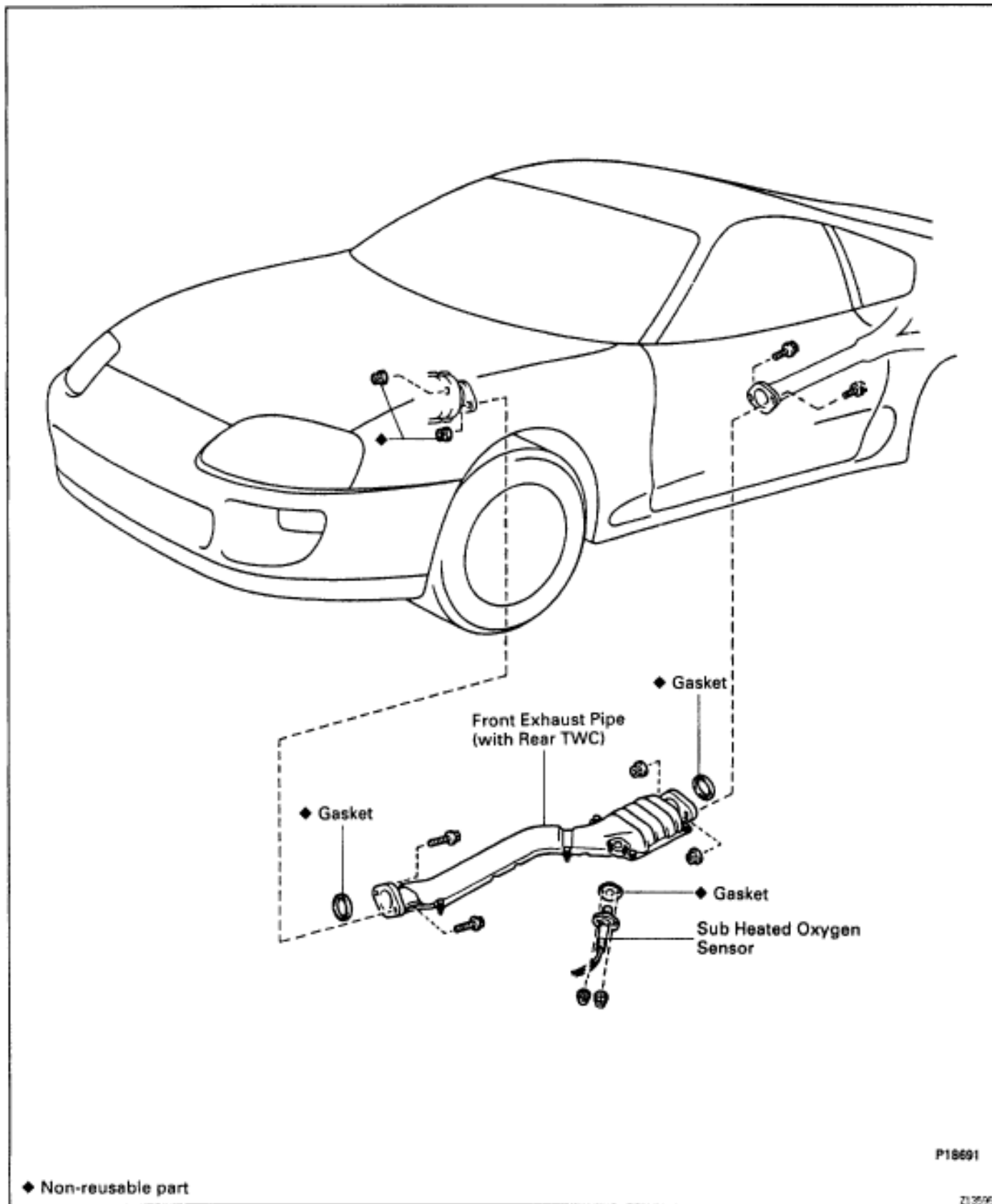

◆ Non-reusable part

P18691

2/3/96

**SERVICE SPECIFICATIONS****TORQUE SPECIFICATIONS**

Part tightened	N·m	kgf·cm	ft·lbf
EGR valve x Air Intake chamber	21	210	15
EGR gas temperature sensor x EGR valve	20	200	14
EGR pipe x Cylinder head	27	280	20
EGR valve x EGR pipe	64	650	47
No.2 front exhaust pipe (Front TWC) x Exhaust manifold	62	630	46
Pipe support bracket x Transmission	43	440	32
No.2 front exhaust pipe (Front TWC) x Front exhaust pipe (Rear TWC)	43	440	32
Front exhaust pipe (Rear TWC) x Center exhaust pipe	43	440	32
Sub heated oxygen sensor x Front exhaust pipe	20	200	14